

# Chapter 3

## Certifying Twisted Pair Cabling

### Setting the Reference

The reference procedure sets a baseline for insertion loss, ELFEXT, and dc resistance measurements.

Run the tester's reference procedure at the following times:

- When you want to use the tester with a different smart remote. You can reference the tester to two different smart remotes.
- Every 30 days. Doing so ensures maximum accuracy of test results.

You do not need to set the reference after changing link interface adapters.

#### Note

*Turn on the tester and smart remote and let them sit for 1 minute before setting the reference. Set the reference only after the testers have reached an ambient temperature between 10 °C and 40 °C (50 °F and 104 °F).*

To set the reference:

- 1 Attach permanent link and channel adapters and make the connections shown in Figure 3-1.
- 2 Turn the rotary switch to **SPECIAL FUNCTIONS** and turn on the smart remote.
- 3 Highlight **Set Reference**; then press **ENTER**. If both a fiber module and copper adapter are attached, select **Link Interface Adapter** next.
- 4 Press **TEST**.



amd41f.eps

**Figure 3-1. Twisted Pair Reference Connections**

## Twisted Pair Test Settings

Table 3-1 describes the settings that apply to twisted pair cabling tests.

To access the settings, turn the rotary switch to **SETUP**, use  to highlight **Twisted Pair**; then press .

**Table 3-1. Twisted Pair Test Settings**

Setting	Description
<b>SETUP &gt; Twisted Pair &gt; Cable Type</b>	Select a cable type appropriate for the type you will test. The cable types are organized by type and manufacturer. Selecting <b>Custom</b> lets you create a cable type. See Chapter 9 for details.
<b>SETUP &gt; Twisted Pair &gt; Test Limit</b>	Select the appropriate test limit for the job. Selecting <b>Custom</b> lets you create a test limit. See Chapter 9 for details.
<b>SETUP &gt; Twisted Pair &gt; NVP</b>	Nominal velocity of propagation, which is used with the measured propagation delay to determine cable length. The default value defined by the selected cable type represents the typical NVP for that cable type. You may enter a different value if necessary. To determine the actual value, change the NVP until the measured length matches the known length of a cable. Use a cable at least 30 m (100 ft) long. See Chapter 9.  Increasing the NVP increases measured length.

-continued-

**Table 3-1. Twisted Pair Test Settings (cont.)**

Setting	Description			
<b>SETUP &gt;</b> <b>Twisted Pair &gt;</b> <b>Outlet</b> <b>Configuration</b>	The <b>Outlet Configuration</b> setting determines which cable pairs are tested and which pair numbers are assigned to the pairs. To see the wire map for a configuration, press (F1) <b>Sample</b> from the <b>Outlet Configuration</b> screen. Selecting <b>Custom</b> lets you create a configuration. See Chapter 9 for details.			
<p style="text-align: center;"><b>T568A</b></p> <pre>                     3 — 1 white/green                        2 green                     2 — 3 white/orange                        1 — 4 blue                           5 white/blue                           6 orange                     4 — 7 white/brown                        8 brown                 </pre>	<p style="text-align: center;"><b>T568B</b></p> <pre>                     2 — 1 white/orange                        2 orange                     3 — 3 white/green                        1 — 4 blue                           5 white/blue                           6 green                     4 — 7 white/brown                        8 brown                 </pre>	<p style="text-align: center;"><b>USOC (1 or 2 Pair)</b></p> <pre>                     2 — 3 white/orange                        1 — 4 blue                           5 white/blue                           6 orange                 </pre> <p style="text-align: center;"><b>Token Ring</b></p> <pre>                     3 — 3 white/green                        1 — 4 blue                           5 white/blue                           6 green                 </pre>	<p style="text-align: center;"><b>ATM/TP-PMD Straight</b></p> <pre>                     1 — 1 white/green                        2 green                     2 — 7 white/brown                        8 brown                 </pre> <p style="text-align: center;"><b>ATM/TP-PMD Crossed</b></p> <pre>                     1 — 1 white/green — 7                        2 — green — 8                     2 — 7 white/brown — 1                        8 — brown — 2                 </pre>	<p style="text-align: center;"><b>Ethernet</b></p> <pre>                     2 — 1 white/orange                        2 orange                     3 — 3 white/green                        6 green                 </pre> <p style="text-align: center;"><b>Ethernet Crossed</b></p> <pre>                     2 — 1 white/orange — 3                        2 — orange — 6                     3 — 3 white/green — 1                        6 — green — 2                 </pre>

-continued-

**Table 3-1. Twisted Pair Test Settings (cont.)**

Setting	Description
<b>SETUP &gt; Instrument Settings &gt; Store Plot Data</b>	<p><b>Standard:</b> The tester displays and saves plot data for frequency-based tests such as NEXT, return loss, and attenuation. The tester saves data for the frequency range required by the selected test limit.</p> <p><b>Extended:</b> The tester saves data beyond the frequency range required by the selected test limit.</p> <p><b>No:</b> Plot data is not saved, which lets you save more results. Saved results show worst margins and worst values for each pair.</p>
<b>SPECIAL FUNCTIONS &gt; Set Reference</b>	<p>The tester must be referenced to the smart remote the first time the two units are used together. You should also set the reference every 30 days. See "Setting the Reference" on page 3-1.</p>
<b>SETUP &gt; Instrument Settings</b>  Settings for saving tests	<p><b>Cable ID Source, Current Folder, Result Storage Location (DTX-1800, DTX-1200), Operator, Site, and Company.</b> See "Preparing to Save Tests" in Chapter 2.</p>

## Autotest on Twisted Pair Cabling

Figure 3-2 shows the equipment needed for certifying twisted pair cabling.



Figure 3-2. Equipment for Certifying Twisted Pair Cabling

To run the Autotest on twisted pair cabling:

- 1 Verify that the settings listed in Table 3-1 are appropriate.
  - 2 Attach adapters appropriate for the job to the tester and the smart remote.
  - 3 Turn the rotary switch to **AUTOTEST** and turn on the smart remote. Connect to the cabling, as shown in Figure 3-3 for a permanent link or Figure 3-4 for a channel.
  - 4 If a fiber module is installed, you may need to press **F1** **Change Media** to select **Twisted Pair** as the media type.
  - 5 Press **TEST** on the tester or smart remote. To stop the test at any time, press **EXIT**.
  - 6 The tester shows the Autotest **Summary** screen when the test is complete (see page 3-10). To view results for a specific parameter, use   to highlight the parameter; then press **ENTER**.
- If the Autotest failed, press **F1** **Fault Info** for possible causes of the failure.
- 7 To save the results, press **SAVE**. Select or create a cable ID; then press **SAVE** again.

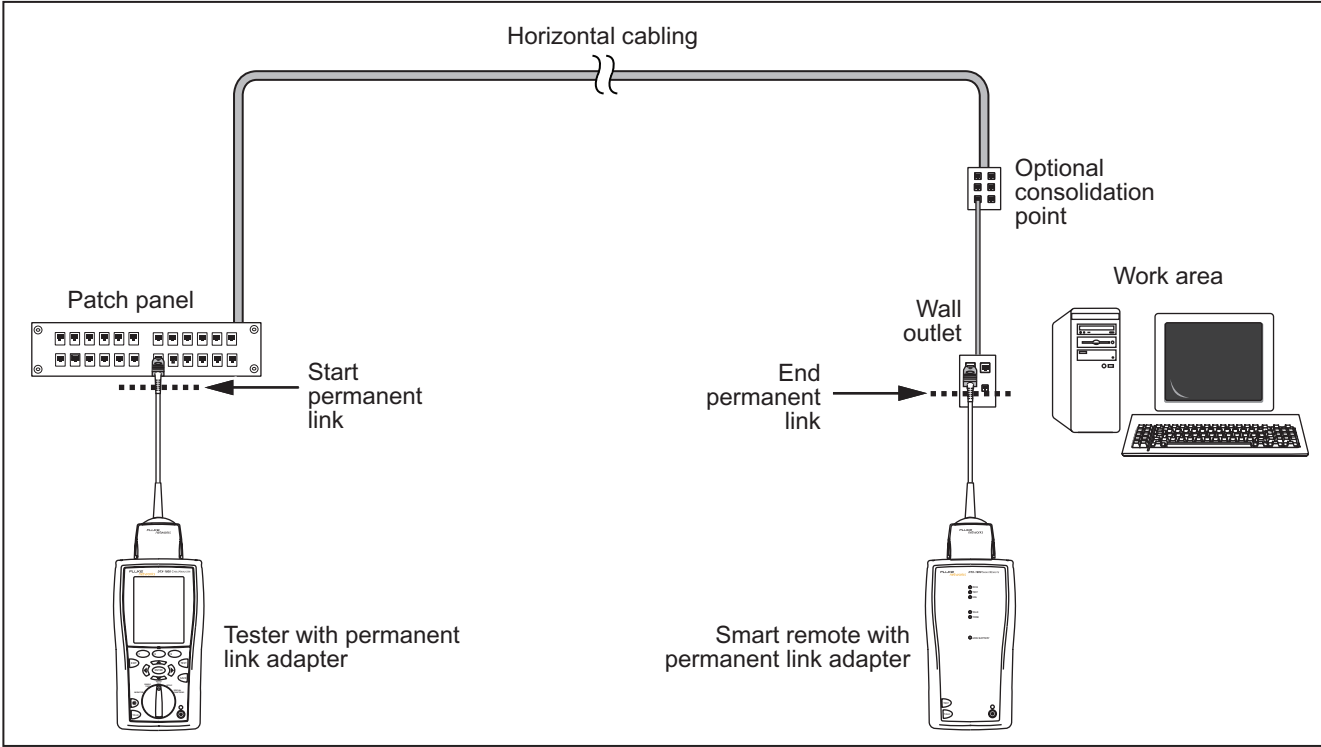

Figure 3-3. Permanent Link Test Connections

amd22f.eps



amd21f.eps

**Figure 3-4. Channel Test Connections**



## **Twisted Pair Autotest Results**

The tests listed below apply to twisted pair cabling.

*Note*

*The Autotest runs some or all of the tests listed below, depending on the selected test limit.*

- Wire map
- Resistance
- Characteristic impedance
- Length
- Propagation delay
- Delay skew
- Insertion loss (attenuation)
- NEXT (near-end crosstalk) and NEXT at the smart remote
- Return loss
- ACR (attenuation to crosstalk ratio) and ACR at the smart remote
- PSACR (power-sum attenuation to crosstalk ratio) and PSACR at the smart remote
- ELFEXT (equal level far-end crosstalk)
- PSELFEXT (power-sum equal level far-end crosstalk)

Figure 3-5 describes the Autotest Summary screen.

Parameter	Value	Status
Wire Map		✓
Resistance		i
Length	89.6 m	✓
Prop. Delay		✓
Delay Skew		✓
Insertion Loss	(29.4 dB)	✓
Return Loss	(-4.0 dB)	✗
NEXT	(-6.1 dB)	✗

amd77f.eps

① **PASS:** All parameters are within limits.  
**FAIL:** One or more parameters exceeds the limit.  
**PASS\*/FAIL\*:** One or more parameters are within the tester's accuracy uncertainty range, and the "\*" notation is required by the selected test standard. See "PASS\*/FAIL\* Results" on page 3-12

② Press (F2) or (F3) to scroll the screen.

③ If the test failed, press (F1) for diagnostic information.

④ Action prompt for the screen. Use to highlight a parameter; then press (ENTER).

⑤ ✓: The measurement was within limits.  
 i: The parameter was measured, but has no PASS/FAIL limit in the selected test limit. The results are for informational purposes only.  
 ✗: The measurement exceeds the limit.  
 \*: See "PASS\*/FAIL\* Results" on page 3-12.

⑥ The worst margin found for the test.

Figure 3-5. Autotest Summary Screen for Twisted Pair Cabling

**Automatic Diagnostics**

If an Autotest fails, press **F1** **Fault Info** for diagnostic information about the failure. The diagnostic screens show likely causes of the failure and suggest actions you

can take to solve the problem. A failed test may produce more than one diagnostic screen. In this case, press  to see additional screens.

Figure 3-6 shows examples of diagnostic screens.

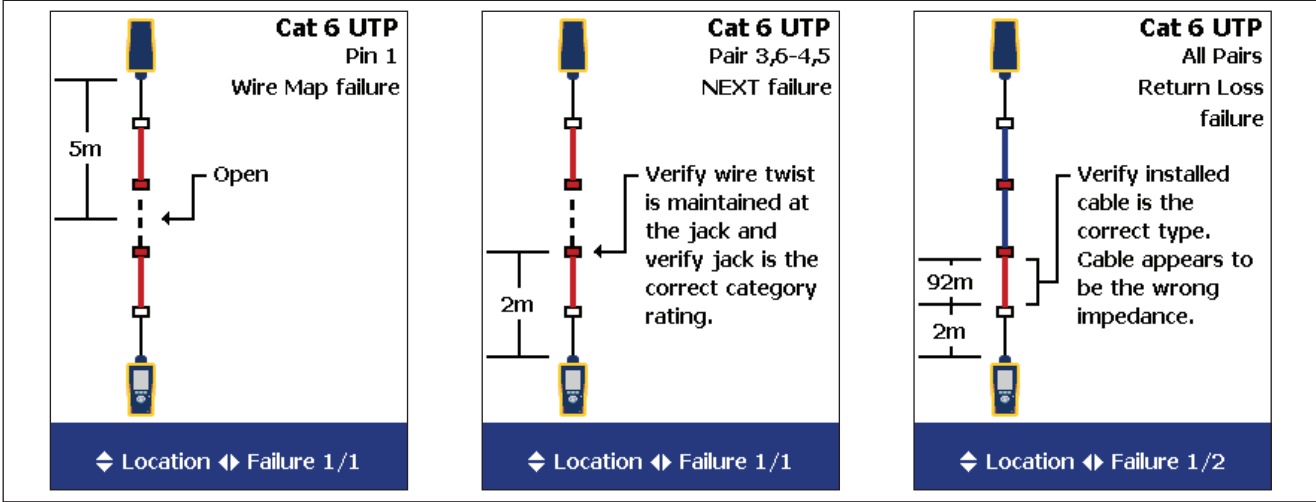

Figure 3-6. Examples of Automatic Diagnostic Screens

amd75f.eps

### **PASS\*/FAIL\* Results**

A result marked with an asterisk means that measurements are in the tester's accuracy uncertainty range (Figure 3-7) and the "\*" notation is required by the selected test standard. These results are considered marginal. Marginal passing and failing results are marked with blue and red asterisks, respectively.

For a **PASS\*** result you should look for ways to improve the cabling installation to eliminate the marginal performance.

A **FAIL\*** result should be considered a failure.

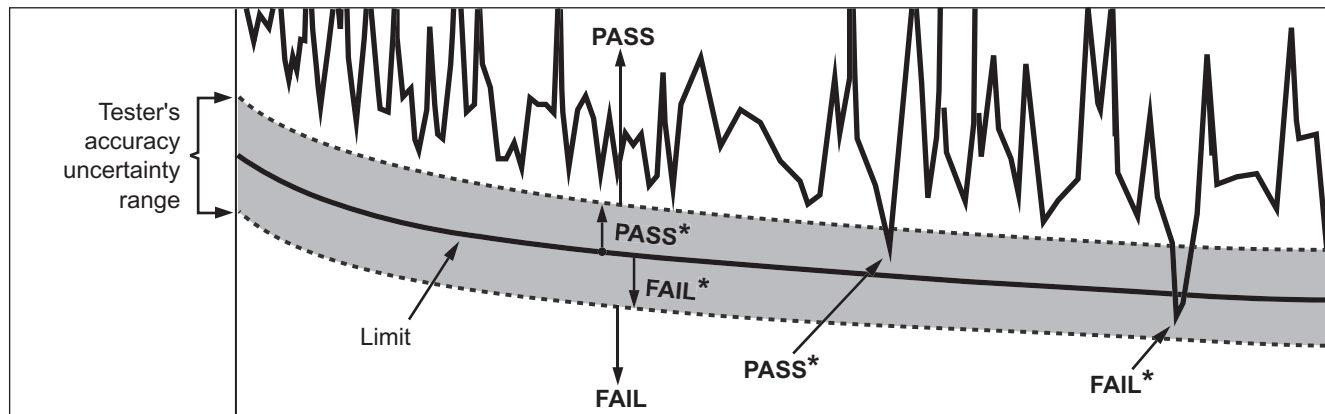

amd42f.eps

**Figure 3-7. PASS\* and FAIL\* Results**

**Wire Map**

Wire map results show the connections between the near and far ends of the cabling. The tester checks the cable pairs required by the selected test limit. If the wire map test fails, the tester lets you choose to continue or stop the Autotest.

**Tip:** The wire map test in Single Test mode features a scanning function that runs the wire map test continuously. This function is helpful for locating intermittent wiring faults.

Figure 3-8 describes examples of wire map screens.

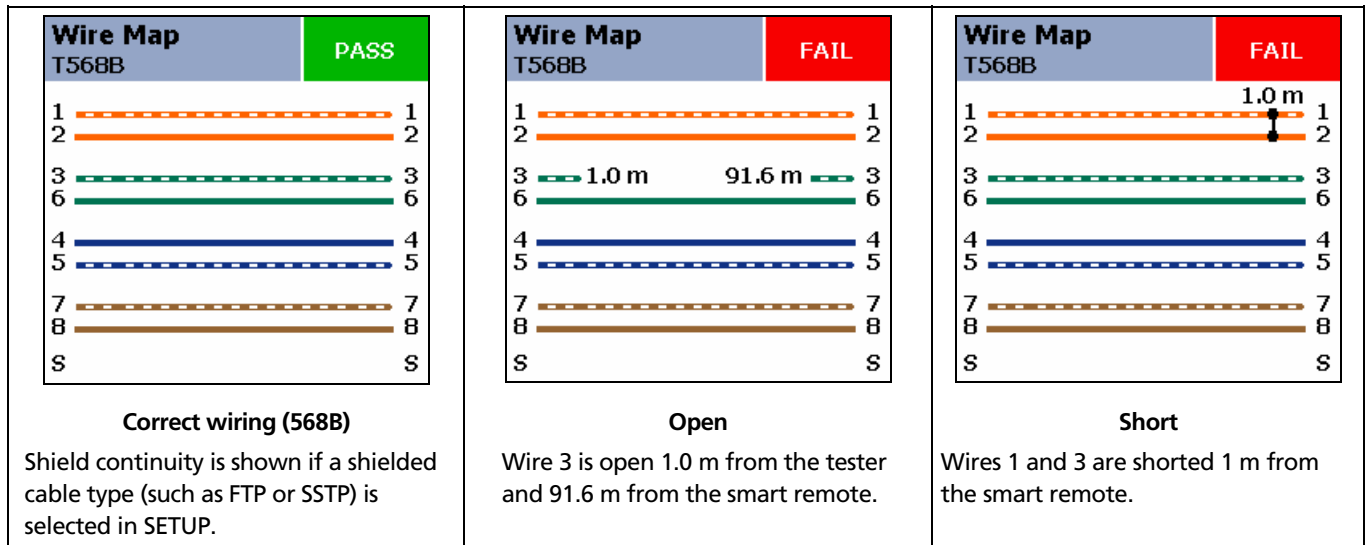

**Figure 3-8. Wire Map Examples**

-continued-



Figure 3-8. Wire Map Examples (cont.)

### Resistance

Resistance results show the dc loop resistance for each cable pair. The smart remote shorts the end of each pair to create the loops. A pair's resistance depends on the integrity of the contacts in the connector, the length of the pair, and its wire gauge.

Resistance problems always affect other tests. For example:

- A link that is too long has higher-than-normal resistance and will fail the length test.
- High-resistance connections reflect signals that cause the return loss test to fail. The tester's HDTDR test tells you the distance to the bad connection.

Most standards do not have a limit for resistance. The tester shows an **i** when no limit is available. Figure 3-9 shows the resistance results screen.

**Tip:** The resistance test in Single Test mode features a scanning function that runs the resistance test continuously. This function is helpful for locating intermittent resistance faults.

Resistance	
Resistance	
<b>i</b> 1	9.8 Ω
2	
<b>i</b> 3	10.0 Ω
6	
<b>i</b> 4	12.5 Ω
5	
<b>i</b> 7	9.8 Ω
8	

Figure 3-9. Resistance Results

amd85f.eps

### Characteristic Impedance

#### Note

*Most test limits do not require the characteristic impedance measurement. Characteristic impedance is not displayed for these limits.*

*Impedance measurements require a cable at least 13 ft (4 m) long. The tester shows **Unknown** for cables shorter than this.*

Characteristic impedance results show approximate characteristic impedance of each cable pair.

Characteristic impedance is the impedance a cable would have if the cable were infinitely long. Proper network operation depends on constant characteristic impedance throughout the system's cables and connectors. Abrupt changes in characteristic impedance, called anomalies, cause signal reflections that can cause network faults.

### Length

Length results show the length of each cable pair. The **PASS/FAIL** result is assigned based on the shortest measured length. A 2 % to 5 % difference in measured length among cable pairs is normal because of the following:

- Signals travel at slightly different speeds in each cable pair, but the tester uses the same speed to calculate the length of each pair.
- The twist rate varies slightly among cable pairs. If you untwisted and straightened all the pairs, they would have slightly different lengths.

Figure 3-10 shows a length results screen, along with propagation delay and delay skew results for comparison.

### Notes

*Differences between measured and actual length values can be caused by variations in the cable's NVP value. NVP values can vary among cable types, lots, and manufacturers. In most cases, these differences are minor and may be disregarded.*

Length		PASS	
	Length	Limit	
✓ 1	81.9 m	90.0 m	
✓ 2			
✓ 3	82.1 m	90.0 m	
✓ 4			
✓ 5	81.7 m	90.0 m	
✓ 6			
✓ 7	82.1 m	90.0 m	
✓ 8			

**Figure 3-10. Length Results**

amd87f.eps



**Propagation Delay and Delay Skew**

Propagation delay is the time taken for a test pulse to travel the length of a cable pair. The delay is measured in nanoseconds. One nanosecond is one-billionth of a second, or 0.000000001 second. Propagation delays vary slightly among pairs because of small differences in electrical characteristics and length.

Delay skews are the differences in propagation delays between the shortest delay and the delays of the other cable pairs. The shortest delay is shown as "0 ns" in the delay skew results.

The propagation delay and delay skew results show a limit if the measurements required by the selected test limit. Otherwise, the results always show **PASS**. Figure 3-11 shows the propagation delay and delay skew results screens.

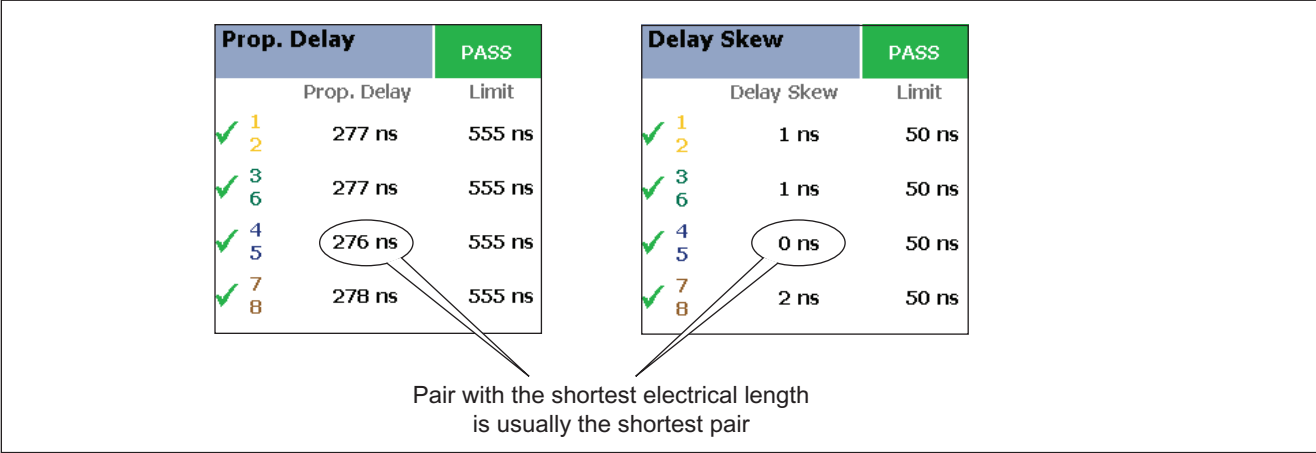

**Figure 3-11. Propagation Delay and Delay Skew Results**

amd88f.eps

## Insertion Loss

### Note

*Insertion loss is also known as attenuation.*

Insertion loss is the loss of signal strength over the cabling, as shown in Figure 3-12. Insertion loss is caused by the resistance of the copper wire and connecting

hardware and by leakage of electrical energy through the cable's insulation.

At higher frequencies, signals tend to travel only near the surface of a conductor. This "skin effect", along with the cabling's inductance and capacitance, cause insertion loss to increase with frequency.

Figure 3-13 describes the insertion loss plot.



**Figure 3-12. Insertion Loss is a Decrease in Signal Strength**

amd90f.eps



Figure 3-13. Insertion Loss Plot

- ① The overall insertion loss result. "PASS\*/FAIL\* Results" on page 3-12 describes results marked with an asterisk.
- ② Magnification level for the plot. Use   to zoom in or out at the cursor's location.
- ③ The limit line (in red) for insertion loss. The lower the measurements fall below the limit line, the better the cabling performance. Press  to see plots of individual pairs.
- ④ Measured insertion loss for the cable pairs. Lower insertion loss means better cabling performance.
- ⑤ The cursor and its location on the frequency scale. When you first view the plot, the cursor is placed at the worst margin. Use  to move the cursor.
- ⑥ The measured insertion loss and margin at the cursor's position. Margin is the difference between the measured value and the limit. Margin is negative if the pair failed.
- ⑦ The horizontal scale is the frequency range in megahertz. The vertical scale is the insertion loss range in decibels.

### **NEXT (Near-End Crosstalk)**

NEXT results show the crosstalk attenuation between cable pairs. NEXT is the difference in amplitude (in dB) between a transmitted signal and the crosstalk received on other cable pairs at the same end of the cabling. Higher NEXT values correspond to better cabling performance.

Because of insertion loss, crosstalk signals occurring farther from the signal source are weaker and cause less trouble than crosstalk nearer the source (Figure 3-14). For this reason, NEXT is measured from both ends of the cabling.

For NEXT failures, the testers diagnostic screens (**F1 Fault Info**) may show more than one possible cause for the failure. In this case, you can use the HDTDX analyzer results to further diagnose the problem. See Chapter 5 for details. Figure 3-15 describes the NEXT plot.

#### *Note*

*For ISO/IEC 11801:2002 and EN50173:2002 standards, NEXT is not evaluated where insertion loss at the same frequency is less than 4 dB. If insertion loss never exceeds 4 dB, NEXT results are marked with an **i** on the tester and an **N/A** in LinkWare reports.*



**Figure 3-14. Near-End Crosstalk (NEXT)**

amd89f.eps



Figure 3-15. NEXT Plot

- ① The location of the NEXT results. Press (F1) to switch between the tester and smart remote.
- ② The overall NEXT result. "PASS\*/FAIL\* Results" on page 3-12 describes results marked with an asterisk.
- ③ Magnification level for the plot. Use to zoom in or out at the cursor's location.
- ④ Measured NEXT for the cable pairs. Higher NEXT means better cabling performance.
- ⑤ The limit line (in red) for NEXT. The higher the measurements rise above the limit line, the better the cabling performance. Press (F3) to see plots of individual pairs.
- ⑥ The cursor and its location on the frequency scale. When you first view the plot, the cursor is placed at the worst margin. Use to move the cursor.
- ⑦ The measured NEXT and margin at the cursor's position. Margin is the difference between the measured value and the limit. Margin is negative if the pair failed.
- ⑧ The horizontal scale is the frequency range in megahertz. The vertical scale is the NEXT range in decibels.

### ACR (Attenuation to Crosstalk Ratio)

ACR is like a signal-to-noise ratio. ACR values indicate how the amplitude of signals received from a far-end transmitter compares to the amplitude of crosstalk produced by near-end transmissions, as shown in Figure 3-16. The tester calculates ACR as the difference (in dB)

between NEXT and attenuation (insertion loss). Higher ACR values mean received signals are much larger than crosstalk signals. Higher ACR values correspond to better cabling performance.

Figure 3-17 describes the ACR plot.



**Figure 3-16. Attenuation to Crosstalk Ratio (ACR)**

amd91f.eps



amd11f.eps

Figure 3-17. ACR Plot

## Return Loss

Return loss is the difference between the power of a transmitted signal and the power of the signals reflected back. The signal reflections are caused by variations in the cable's impedance. Figure 3-18 shows some common sources of reflections that create return loss.

High return loss means the cabling reflects very little of the transmitted signal back to the source. High return loss is especially important for high-speed systems, such as Gigabit Ethernet. The bi-directional (full-duplex) transceivers used in these systems use directional couplers to distinguish between incoming and outgoing signals. The couplers may interpret strong reflected signals as incoming data, resulting in data errors.

A return loss plot indicates how well a cable's impedance matches its rated impedance over a range of frequencies. Figure 3-19 describes the return loss plot.

For return loss failures, the testers diagnostic screens (F1) **Fault Info** may show more than one possible cause for the failure. In this case, you can use the HDTDR analyzer results to further diagnose the problem. See Chapter 5 for details.

### Note

*For ANSI/TIA/EIA-568-B.2-3 and ISO/IEC 11801:2002 6.4.2 standards, return loss is not evaluated where insertion loss at the same frequency is less than 3 dB. If insertion loss never exceeds 3 dB, return loss results are marked with an **i** on the tester and an NIA in LinkWare reports.*



**Figure 3-18. Sources of Return Loss**

amd93f.eps





- ① The location of the return loss results. Press (F1) to switch between the tester and smart remote.
- ② The overall return loss result. "PASS\*/FAIL\* Results" on page 3-12 describes results marked with an asterisk.
- ③ Magnification level for the plot. Use to zoom in or out at the cursor's location.
- ④ Measured return loss for the cable pairs. Higher return loss means better cabling performance.
- ⑤ The limit line (in red) for return loss. The higher the measurements rise above the limit line, the better the cabling performance. Press (F3) to see plots of individual pairs.
- ⑥ The cursor and its location on the frequency scale. When you first view the plot, the cursor is placed at the worst margin. Use to move the cursor.
- ⑦ The measured return loss and margin at the cursor's position. Margin is the difference between the measured value and the limit. Margin is negative if the pair failed.
- ⑧ The horizontal scale is the frequency range in megahertz. The vertical scale is the return loss range in decibels.

Figure 3-19. Return Loss Plot

### **PSNEXT (Power Sum Near End Crosstalk) Test**

PSNEXT results show how much each cable pair is affected by the combined crosstalk from the other pairs. PSNEXT is the difference (in dB) between the test signal and the crosstalk from the other pairs received at the same end of the cabling. The tester uses the NEXT values to calculate PSNEXT. Higher PSNEXT values correspond to better cabling performance.

PSNEXT results are typically a few dB lower (worse) than worst-case NEXT results.

### **PSACR (Power Sum Attenuation to Crosstalk Ratio) Test**

PSACR values indicate how the amplitude of signals received from a far-end transmitter compares to the combined amplitudes of crosstalk produced by near-end transmissions on the other cable pairs. PSACR is the difference (in dB) between PSNEXT and attenuation (insertion loss). The tester uses the PSNEXT and attenuation results to calculate PSACR values. Higher PSACR values mean received signals are much larger than the crosstalk from all the other cable pairs. Higher PSACR values correspond to better cabling performance.

PSACR is the difference (in dB) between each wire pair's attenuation (insertion loss) and the combined crosstalk

received from the other pairs. The tester uses the PSNEXT and attenuation values to calculate PSACR values.

PSACR results are typically a few dB lower (worse) than worst-case ACN results.

### **ELFEXT (Equal Level Far-End Crosstalk) Test**

While NEXT is measured at the same end as the signal source, FEXT (far-end crosstalk) is measured at the far end. Because all far-end crosstalk signals travel the same distance, they experience the same amount of attenuation, as shown in Figure 3-20. This means that all crosstalk signals contribute equally to noise at the far end. This is different from near-end crosstalk. At the near end, crosstalk occurring closer to the source contributes more to noise than crosstalk occurring farther from the source. (Figure 3-14).

Because of attenuation, FEXT on longer cables is less than FEXT on shorter cables of the same type. Subtracting the effects of attenuation normalizes the results for length and produces ELFEXT (equal level far end crosstalk) values. Since ELFEXT does not depend on length, it is used instead of FEXT to evaluate cable performance.

Because all far-end crosstalk signals travel the same distance, they tend to add up in phase. Therefore, high ELFEXT is critical when two or more wire-pairs carry signals in the same direction. 1000BASE-T carries bi-

directional signals on all four wire pairs, so ELFEXT is a critical parameter for 1000BASE-T certification.

Like ACR, ELFEXT represents a signal-to-noise ratio for the cabling. Higher ELFEXT values mean that data signals received at the far end of the cabling are much larger than crosstalk signals received at the far end. Higher ELFEXT values correspond to better cabling performance.

NEXT and ELFEXT performance tends to be similar in cable, but may differ greatly in connecting hardware.

Some connectors achieve good NEXT performance by balancing the inductive and capacitive currents that cause crosstalk. Since these currents are 180° out of phase at the near-end of the cabling, they cancel out, which eliminates crosstalk at the near end. However, currents that cancel at the near end add up at the far end, causing far-end crosstalk and poor ELFEXT performance.

Figure 3-21 describes the ELFEXT plot.



amd94f.eps

**Figure 3-20. Far-End Crosstalk (FEXT)**



Figure 3-21. ELFEXT Plot

### **PSELFEXT Test**

PSELFEXT results show how much the far end of each cable pair is affected by the combined far-end crosstalk from the other pairs. PSELFEXT is the difference (in dB) between the test signal and the crosstalk from the other pairs received at the far end of the cabling. The tester uses the ELFEXT values to calculate PSELFEXT. Higher PSELFEXT values correspond to better cabling performance.

PSELFEXT results are typically a few dB lower than worst-case FEXT results.

### **Running Single Tests**

The tester's single test mode (**SINGLE TEST** on the rotary switch) lets you run individual tests for isolating cabling failures and quickly testing repairs. You can run some single tests without a remote. Table 3-2 shows which tests require a smart remote.

Single tests use the selected test limit to produce a PASS/FAIL result for the test. Each single test also produces results for other measurements. For example, the wire map test also produces resistance, propagation delay, and delay skew results. To see these results, press  when the single test is finished; then press  **View Results**.

To save a single test, press , select or create a cable ID; then press  again.

**Table 3-2. Smart Remote Requirements for Twisted Pair Single Tests**

Test	Smart Remote Requirements*
HDTDX analyzer	Recommended. Without a smart remote, results for short cables may be unreliable.
HDTDR analyzer	Optional. Without a smart remote, the plot shows large reflections at the end of the cabling.
Wire Map	Recommended. Without a remote some faults, such as split pairs and opens at the far-end connector, cannot be detected.
Resistance	Optional.
Impedance	Optional. Test is available only for limits that require the impedance measurement.
Length	Optional.
Propagation Delay	Optional.
Delay Skew	Optional.
Insertion Loss	Required.
NEXT/PSNEXT	Recommended. The NEXT test fails unless the end of the cabling is properly terminated with a remote or resistors.
ELFEXT/PSELFEXT	Required.
ACR/PSACR	Required.
Return Loss	Recommended. The return loss test fails unless the end of the cabling is properly terminated with a remote or resistors.
* Note: If a remote is not required for a test, the test runs without activating the toner when no remote is detected.	

### Monitoring Impulse Noise

Impulse noise is electrical noise generated by fluorescent lights, electric motors, electric heaters and air conditioners, photocopiers, refrigerators, microwave ovens, and other electric devices. Active links in the same pathway can also cause noise.

Noise distorts the shape of digital signals, as shown in Figure 3-22. Too much noise can cause transmission errors, resulting in poor network performance.

The impulse noise test lets you monitor noise on inactive twisted pair cabling to determine if the noise may affect network operation.

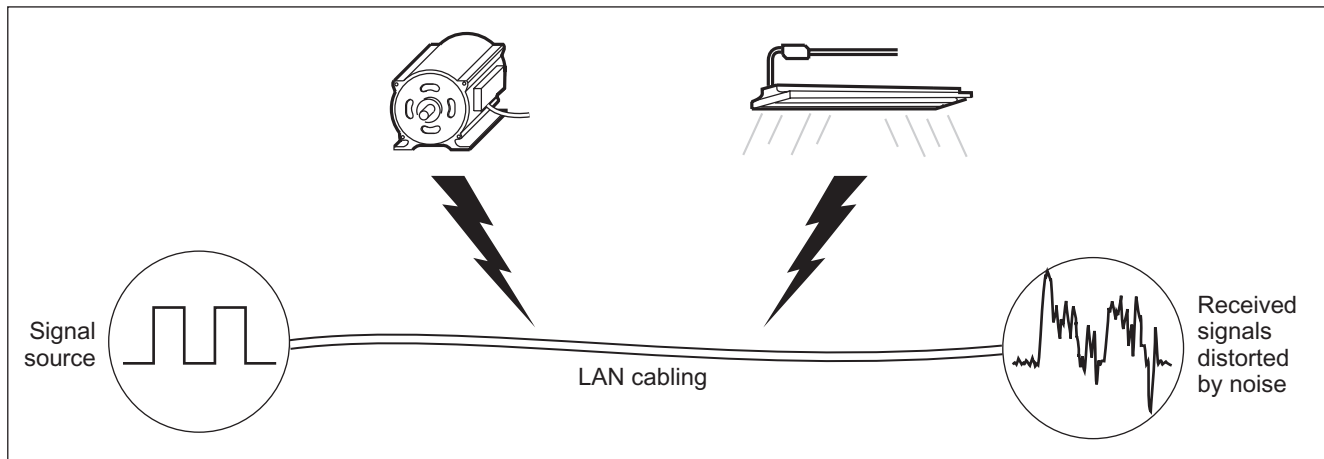

amd95f.eps

Figure 3-22. Causes and Effects of Noise

The test takes noise voltage samples every second on pair 3, 6. The test produces a PASS/FAIL result if the selected standard specifies a noise limit.

#### Notes

*To extend battery life, connect the ac adapter when monitoring impulse noise for extended periods. The tester's power down timer is disabled during the impulse noise test.*

*Monitoring impulse noise without a smart remote may produce unreliable test results.*

To monitor impulse noise:

- 1 Attach twisted pair link interface adapters to the tester and smart remote.
- 2 Turn the rotary switch to **MONITOR** and turn on the smart remote; then connect to the testers to the ends of the cabling.
- 3 Press .

To adjust the noise threshold, press  **Stop**; then use   to change the value. Press  to resume testing.

**Tip:** Fluke Networks recommends a noise threshold of 30 mV with an average pulse rate below 0.01/sec for testing 1000BASE-T (Gigabit Ethernet) cabling.

To stop the test at any time, press .

#### Note

*If you disconnect the tester and smart remote during the impulse noise test, it takes several minutes for the remote to stop testing.*

Figure 3-23 describes the impulse noise test results.





Figure 3-23. Impulse Noise Test Results

## Using the Tone Generator

The tone generator on the tester and smart remote produces a distinct signal for locating cables and jacks with a tone probe such as a Fluke Networks IntelliTone™ probe. The tone probe converts the toner's signal to audible tones that get louder as you get closer to the cable or jack transmitting the signal.

The tone generator also activates a sleeping or powered-down tester or smart remote connected to the other end of the cabling.

### Note

*The tone generator does not generate the IntelliTone signal.*

To use the tone generator:

- 1 Attach a twisted pair adapter to the tester or smart remote.
- 2 Connect the tester or smart remote to the cabling as shown in Figure 3-24.
- 3 To turn on the tester's toner, turn the rotary switch to **AUTOTEST** or **SINGLE TEST**; then press .

To turn on the smart remote's toner, press .

- 4 Use a tone probe to locate the cable or jack transmitting the tone.

### Notes

*The toner's signal may not be detectable along shielded cable, but can be detected at a patch panel or outlet.*

- 5 To start the test selected on the tester, connect the far-end unit to the cabling.

To turn off the tester's toner, press .

To turn off the smart remote's toner, press .



Figure 3-24. Using the Tone Generator

amd96f.eps